

1

2

A

A

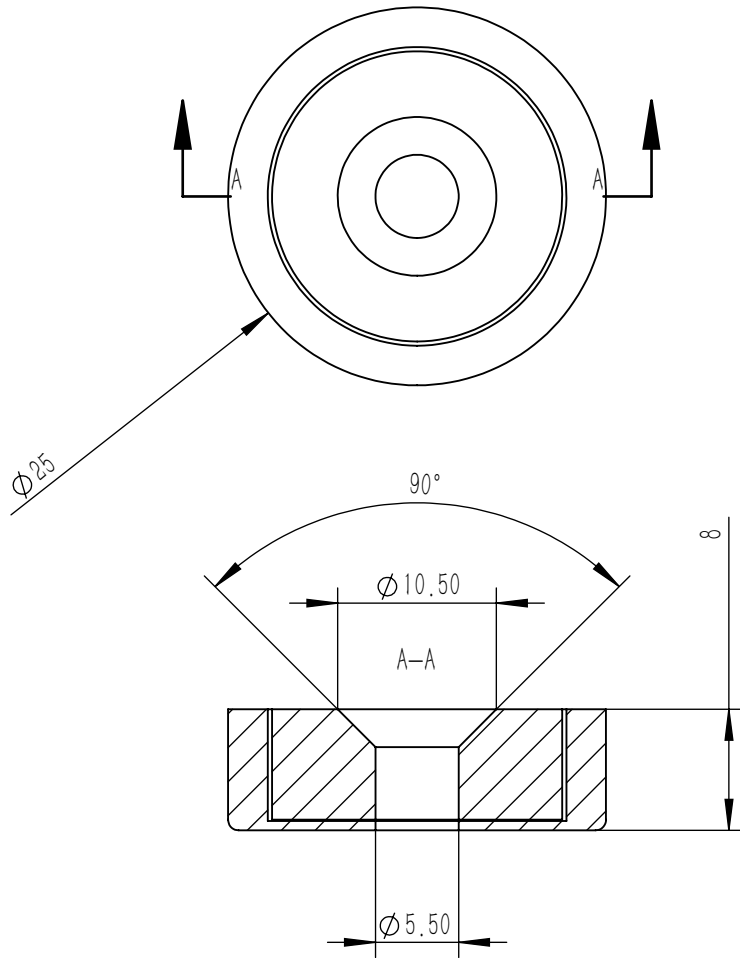

N52 Magnet

Steel Cup

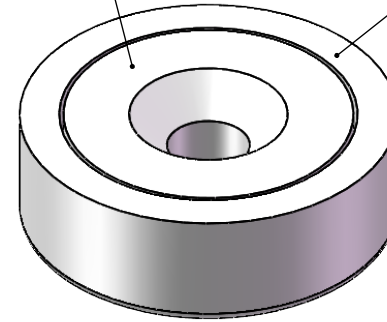

B

B

PROPRIETARY AND CONFIDENTIAL
 THE INFORMATION CONTAINED IN THIS DRAWING IS THE SOLE PROPERTY OF LIFTSUN
 MAGNETS. ANY REPRODUCTION IN PART OR AS A WHOLE WITHOUT THE WRITTEN
 PERMISSION OF LIFTSUN MAGNETS IS PROHIBITED.

UNLESS OTHERWISE SPECIFIED:

DIMENSIONS ARE IN MM
TOLERANCES: +/-0.1

MATERIAL
NdFeB

Grade
N52

FINISH
Ni-Cu-Ni

DO NOT SCALE DRAWING

Liftsun Magnets

TITLE: Pot Magnets		
SIZE A	DWG. NO. LSM0039	REV
SCALE: 2:1	WEIGHT:	SHEET 1 OF 1

1

2